

SECTION A-A

NOTES:

1. MATERIAL:
 - HOUSING: THERMAL PLASTIC, G.F., UL94V-0, COLOR: BLACK
 - COVER: THERMAL PLASTIC, COLOR: BLACK
 - TERMINAL: COPPER ALLOY
 - METAL LATCH: STAINLESS STEEL
2. TERMINAL PLATING:
 - CONTACT AREA: GOLD PLATED
 - IDT TAIL: PLATE TIN, 1.9 MICRONS MINIMUM
 - UNDER PLATE: PLATE NICKEL 1.25 MICRONS MINIMUM
3. PACKAGING: TRAY
4. PRODUCT SPECIFICATION REFER TO PS-67490-001
5. ASSEMBLE WITH COVER 679260040/0041 AFTER WIRE TERMINATION
6. MATING PART 87679
7. RECOMMENDED TERMINATING WIRE SIZE: SEE TABLE
8. PRODUCT COMPLIANT TO RoHS DIRECTIVE 2002/95/EC AND ELV DIRECTIVE 2000/53/EC

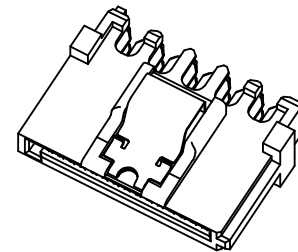

WITH LATCH TYPE

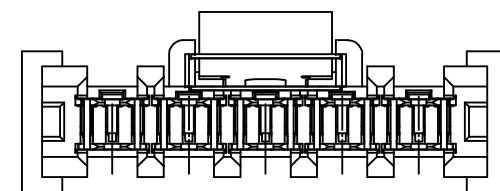
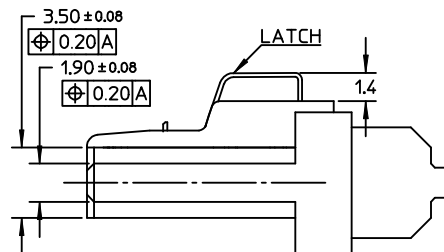
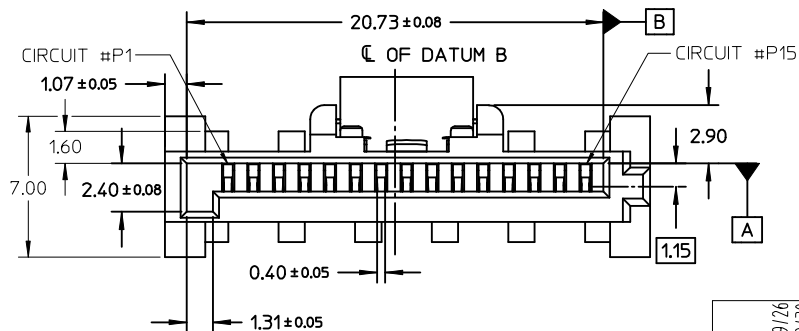

REVISED EC NO: SH2009-0098 DRW: CWTANG CHK: XJSONG APPR: HWANG	DESCRIPTION 2008/09/26 2008/09/30 2008/11/01	QUALITY SYMBOLS	GENERAL TOLERANCES (UNLESS SPECIFIED)		DIMENSION STYLE		SCALE	DESIGN UNITS	THIRD ANGLE PROJECTION		
		▽=0 ◻=0	mm	INCH	MM ONLY	4:1	METRIC	SERIAL ATA POWER CONNECTOR IDT TYPE			
		4 PLACES ± --- ± --- 3 PLACES ± --- ± --- 2 PLACES ± 0.25 ± --- 1 PLACE ± 0.3 ± ---	DRAWN BY DATE GRATE MA 2004/01/17		CHECKED BY DATE YAJUN 2004/01/17		APPROVED BY DATE SAM 2004/01/17		MOLEX INCORPORATED		
		ANGULAR ± 1 ° DRAFT WHERE APPLICABLE MUST REMAIN WITHIN DIMENSIONS	MATERIAL NO. SEE CHART		DOCUMENT NO. SD-67926-001		SHEET NO. 1 OF 3		THIS DRAWING CONTAINS INFORMATION THAT IS PROPRIETARY TO MOLEX INCORPORATED AND SHOULD NOT BE USED WITHOUT WRITTEN PERMISSION		

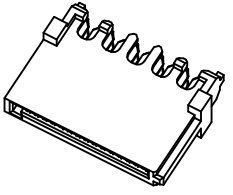
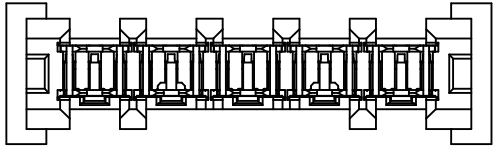

WITHOUT LATCH TYPE

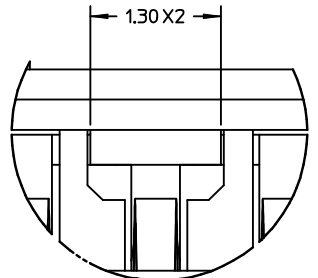
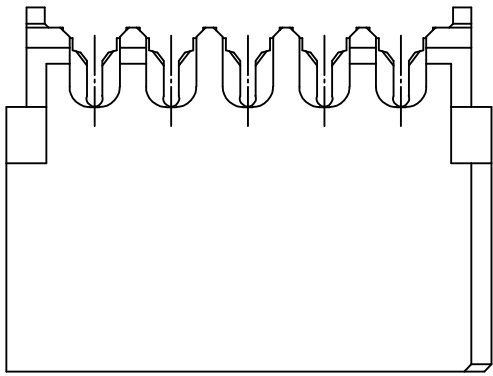

Detail2

SCALE 20:1

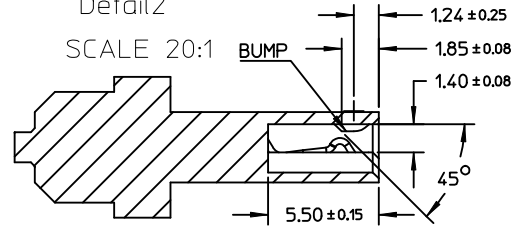

SECTION B-B

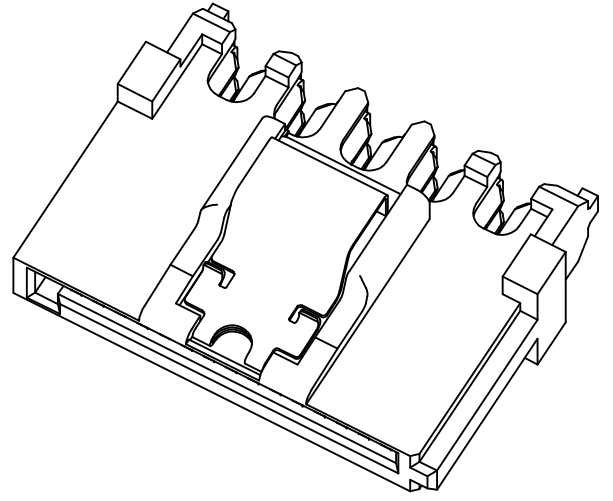
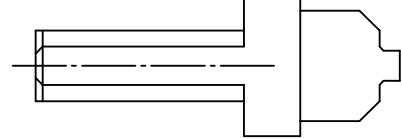

See Detail2

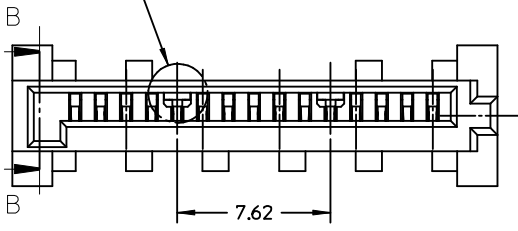

NOTES:
OTHER INFORMATION REFER TO SHEET 1

REVISED EC NO: SH2009-0098 G DRWIN: CWTANG CHKD: XJSONG APPR: HHWANG	2008/09/26 2008/09/30 2008/11/01	DESCRIPTION REV	QUALITY SYMBOLS	GENERAL TOLERANCES (UNLESS SPECIFIED)	DIMENSION STYLE	SCALE	DESIGN UNITS	THIRD ANGLE PROJECTION	
			▼=0 C=0	mm INCH 4 PLACES ± --- ± --- 3 PLACES ± --- ± --- 2 PLACES ± 0.25 ± --- 1 PLACE ± 0.3 ± --- ANGULAR ± 1 °	MM ONLY	4:1	METRIC	DRAWN BY DATE GRATE MA 2004/01/17 CHECKED BY DATE YAJUN 2004/01/17 APPROVED BY DATE SAM 2004/01/17	TITLE
			DRAFT WHERE APPLICABLE MUST REMAIN WITHIN DIMENSIONS	SEE CHART	MATERIAL NO. SD-67926-001	SERIAL ATA POWER CONNECTOR IDT TYPE	MOLEX INCORPORATED		
			SIZE A3	THIS DRAWING CONTAINS INFORMATION THAT IS PROPRIETARY TO MOLEX INCORPORATED AND SHOULD NOT BE USED WITHOUT WRITTEN PERMISSION	DOCUMENT NO. SD-67926-001	SHEET NO. 2 OF 3			

P/N	RECOMMENDED WIRE SIZE	PLATE TYPE	REMARK
67926-0001	18AWG	GOLD FLASH	WITH LATCH,WITHOUT BUMP
67926-0301	20AWG		
67926-0401	22AWG		
67926-0002	18AWG	0.76 MICRON GOLD PLATED	
67926-0302	20AWG		
67926-0402	22AWG		
67926-0005	18AWG	0.38 MICRON GOLD PLATED	
67926-0305	20AWG		
67926-0405	22AWG		
67926-0021	18AWG	GOLD FLASH	WITH LATCH,WITH BUMP
67926-0321	20AWG		
67926-0421	22AWG		
67926-0022	18AWG	0.76 MICRON GOLD PLATED	
67926-0322	20AWG		
67926-0422	22AWG		
67926-0025	18AWG	0.38 MICRON GOLD PLATED	
67926-0325	20AWG		
67926-0425	22AWG		
67926-0011	18AWG	GOLD FLASH	WITHOUT LATCH,WITH BUMP
67926-0311	20AWG		
67926-0411	22AWG		
67926-0012	18AWG	0.76 MICRON GOLD PLATED	
67926-0312	20AWG		
67926-0412	22AWG		
67926-0015	18AWG	0.38 MICRON GOLD PLATED	
67926-0315	20AWG		
67926-0415	22AWG		

REVISED EC NO: SH2009-0098 DRWN: CWTANG CHKD: XJSONG APPR: HWANG	2008/09/26 2008/09/30 2008/11/01	DESCRIPTION REV	QUALITY SYMBOLS	GENERAL TOLERANCES (UNLESS SPECIFIED)	DIMENSION STYLE	SCALE	DESIGN UNITS	THIRD ANGLE PROJECTION
			▽=0 □=0	mm INCH	MM ONLY	4:1	METRIC	
			4 PLACES ± --- ± --- 3 PLACES ± --- ± --- 2 PLACES ± 0.25 ± --- 1 PLACE ± 0.3 ± --- ANGULAR ± 1 °	DRAWN BY DATE GRATE MA 2004/01/17 CHECKED BY DATE YA JUN 2004/01/17 APPROVED BY DATE SAM 2004/01/17	TITLE			
			DRAFT WHERE APPLICABLE MUST REMAIN WITHIN DIMENSIONS	MATERIAL NO. SEE CHART SIZE A3	SERIAL ATA POWER CONNECTOR IDT TYPE MOLEX INCORPORATED DOCUMENT NO. SD-67926-001	SHEET NO. 3 OF 3		